

REVISED PROPOSAL

University Academic Center

Eastern USA



Alexander Altemose

Structural Option

Advisor: Thomas E. Boothby

January 11, 2013

Table of Contents

Executive Summary.....	3
Introduction	4
Structural Overview	5
Foundation	5
Floor and Roof System	7
Framing System	8
Lateral System	8
Design Codes.....	9
Design Loads.....	10
Dead Loads	10
Live Loads	10
Snow Loads.....	11
Wind Loads.....	12
Seismic Loads	15
Load Combinations.....	16
Wind Load Cases.....	18
Seismic Load Cases.....	18
Proposed Structural Depth.....	19
Breadth 1: Lighting Impact.....	20
Breadth 2: Construction Impact.....	20
Tasks and Tools	20
Conclusion	21
Schedule.....	22
Appendix: Floor plans.....	23

Executive Summary

This proposal will outline the intended areas of study to be done in the spring semester report. These areas of study will include a structural depth through research and redesign of the University Academic Center along with two related breadth studies.

The University Academic Center is composed of a composite structural steel floor system and concentrically braced frame lateral system. Building layout includes three major wings: the north café/fitness wing, the central classroom wing, and the south office wing. The north and south wings are clad in a brick façade whereas the center wing is covered in metal panels.

This proposal will outline the idea of redesigning the office wing into a concrete structural system in order to further knowledge in a different building material than previously discussed in the technical reports. Along with the concrete redesign, the architectural and construction impacts will be researched as breadth topics.

A concrete redesign of the office wing seemed practical due to its brick façade already giving this wing a more massive appearance, and the repeated floor layout should allow for the reuse of formwork. The surrounding locale also favors concrete as a building material. Research done in technical report 2 of alternative floor systems showed a two-way slab to be a feasible alternative with lower cost and less overall depth. Research done in technical report 3 showed a strong torsional effect due to the lateral system's layout of braced frames. By changing the lateral system to concrete moment connections in the office wing; this torsional effect will hopefully be reduced.

Introduction

Located in the eastern United States, the University Academic Center is a 192,000 square foot building designed to house a library resource center, dining area, 45 classrooms, and over 120 offices. Other key features include a 5-story atrium and multiple roof gardens.

The layout of the building consists of three main sections. The northern 3-story section contains mostly dining and classroom areas. In the center of the building, a 4 story section houses the library and the majority of classrooms, as well as acting as the main entrance. The southern end of the building consists almost entirely of office spaces. On either side of the center section are the vertical circulation cores which also provide access to the roof gardens.

There are 4 main types of building façade implemented in this building. The 3 and 5-story sections of the building have a brick façade with cast stone bands running horizontally across the brick surface. Glass curtain walls are used in the vertical circulation located on either side of the 4-story section. The 4-story section's façade is mostly metal panels. There is also glazed CMU used to accent the other façade types at various places.

Through the use of multiple energy saving techniques the University Academic Center holds a LEED gold rating. This includes energy efficient HVAC equipment and the use of natural daylighting, as well as shading devices, to help minimize energy consumption. All these features, along with the roof gardens, provide a "green" learning environment. LEED credits were also gained through site design to minimize storm water runoff, use of recyclable and local materials, and the addition of bike racks and on site showering facilities to promote alternative modes of transportation.

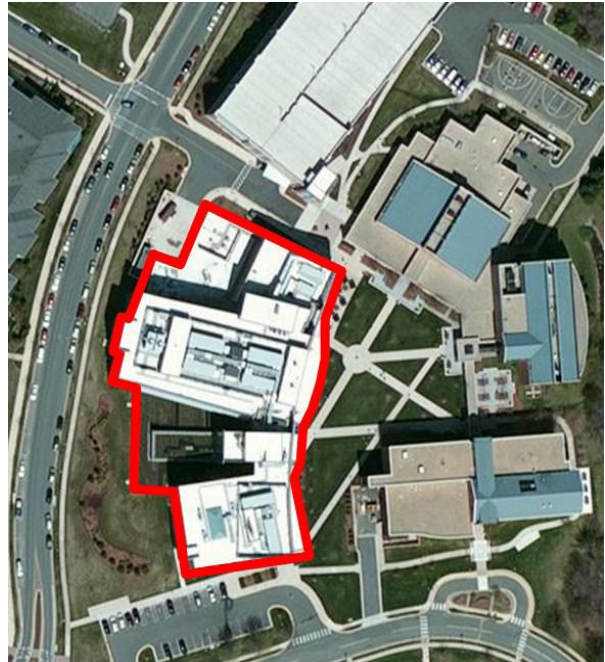

Photo taken from Bing Maps

Structural Overview

The University Academic Center is a steel framed building with composite metal decking supported by a foundation of spread footings and slab-on-grade. The building resists lateral forces by a combination of braced and moment frames.

Foundation

Based on the 2002 geotechnical report taken, footings for University Academic Center are designed for an allowable bearing capacity of 3,000 psf. Footings are placed on undisturbed soil or on structurally compacted fill. The bottoms of exterior footings are 2'-6" below grade.

Slab-on-grade sits on a coarse granular fill material compacted to 95% of maximum density as defined by ASTM D1557 modified proctor test. The slab-on-grade is designed as 5" thick concrete reinforced with 6"x6", W1.4xW1.4 WWF. This is the reinforcement for all slab-on-grade except for the area located under the library stacks which is 6" thick concrete reinforced with 2 layers of 6"x6", W2.1xW2.1 WWF.

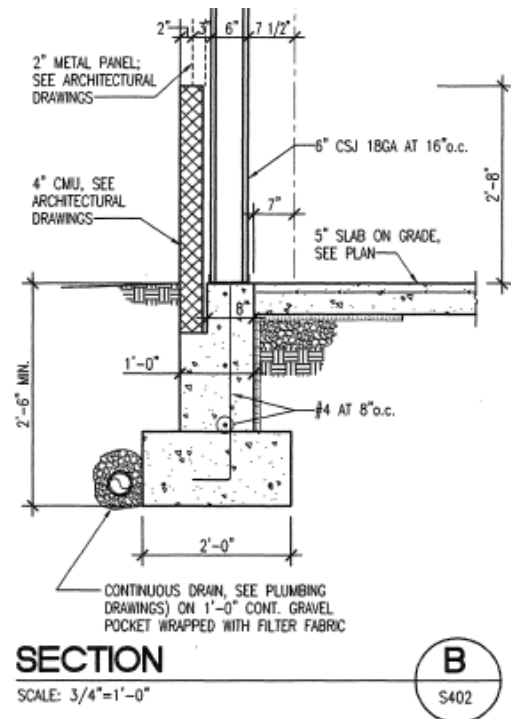
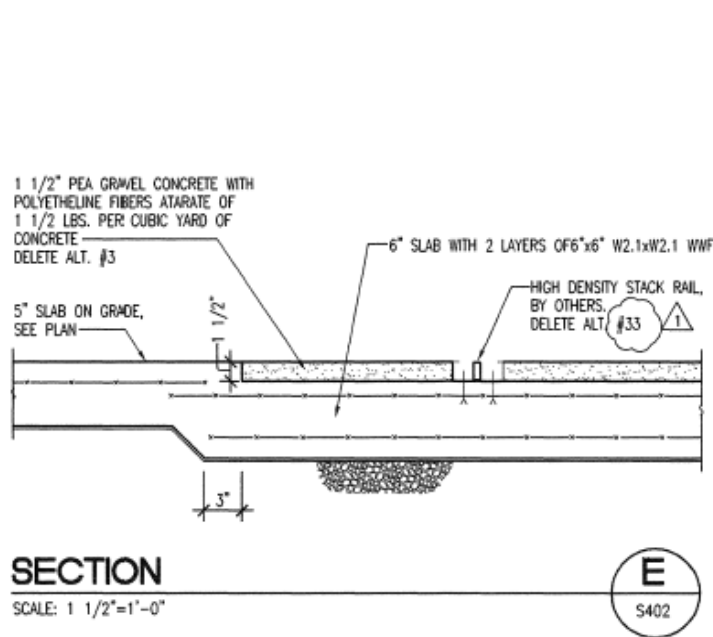

Drawings provided by Skanska

The columns in the University Academic Center bear on piers ranging in size depending on loading and connection type. These piers are a minimum of 8" ranging to a maximum depth of 3'-9". The piers come in 4 types: 4, 6, 8, and 12 vertical bar piers. Footings also range in size under the columns with a maximum 19'x19' under a single column.

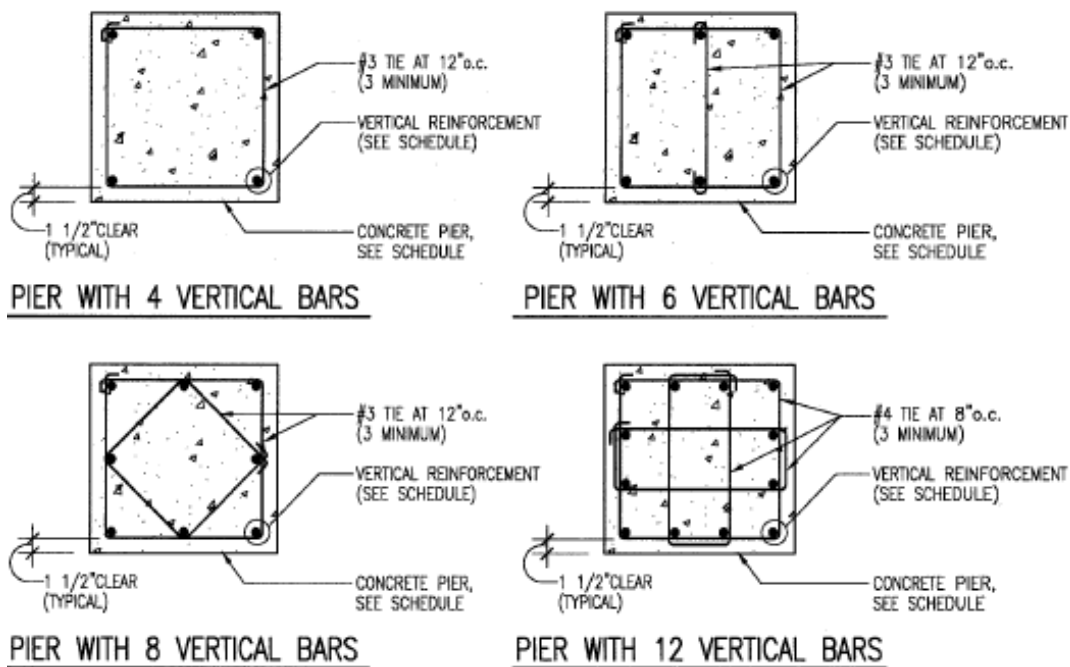

CONCRETE PIER REINFORCING DETAILS 10
S401

Drawings provided by Skanska

Floor and Roof Systems

The University Academic Center utilizes a composite metal deck flooring system. This includes 2" composite 20 gage deck with ribs 12" o.c. and 1.5" type B, wide rib 20 gage deck. All metal deck is designed to be continuous over 3 spans. Floor system also includes shear studs and lightweight concrete topping varying based on location and loading.

Roofing systems also varies due to some areas like the roof gardens and mechanical spaces of greater loading. Decking for roofs includes both 2" composite 18 gage deck with ribs 12" o.c. and 1.5" type B, wide rib 20 gage deck, covered by a built up roof and rigid insulation.

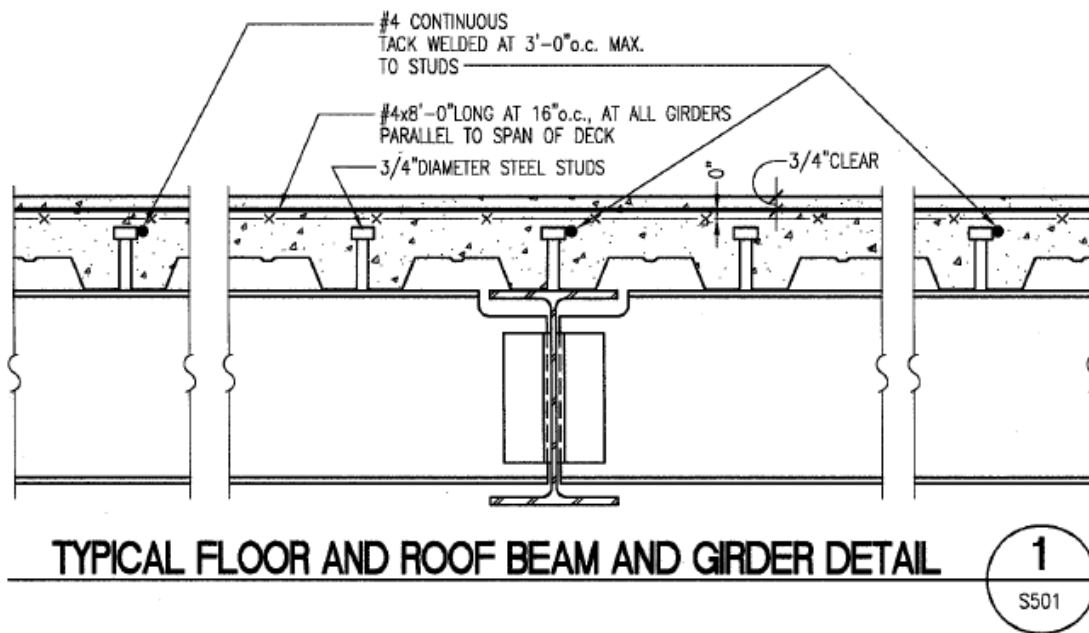

Drawings provided by Skanska

Framing System

The framing system for the University Academic Center includes C-shapes, HSS members, and Wide Flange members with the majority being W-shapes. Gridlines are set at multiple angles with bay sizes varying throughout the building. Areas with consistent framing between floors are located in the classroom wing in the central section of the building and the office spaces on the south side. The gravity system transfers vertical loads due to dead, live, and snow loading across a floor or roof deck, into beams and girders, and is taken as axial force in columns to the foundation.

Lateral System

The lateral system for this building includes braced frames of varying heights and types located throughout the building. Below is a plan view of University Academic Center with the 15 lateral braced frames shown in blue. These frames resist the forces on the building due to wind and seismic loading. The wind loads are taken into the floor diaphragm from the façade and distributed amongst the bracing based on relative stiffness. The frames in turn transfer these loads to the foundation. A braced framing system is logical with a steel building given the lightweight paired with relative stiffness. Where shear walls would limit the circulation throughout the building, using knee braces, as University Academic Center does in multiple locations, allows for more useable space. Braced frames are also stiffer than moment framing alternatives and cheaper to construct.

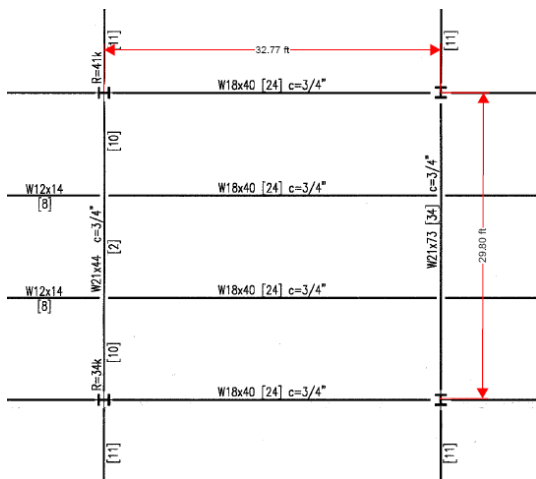

Drawings provided by Skanska

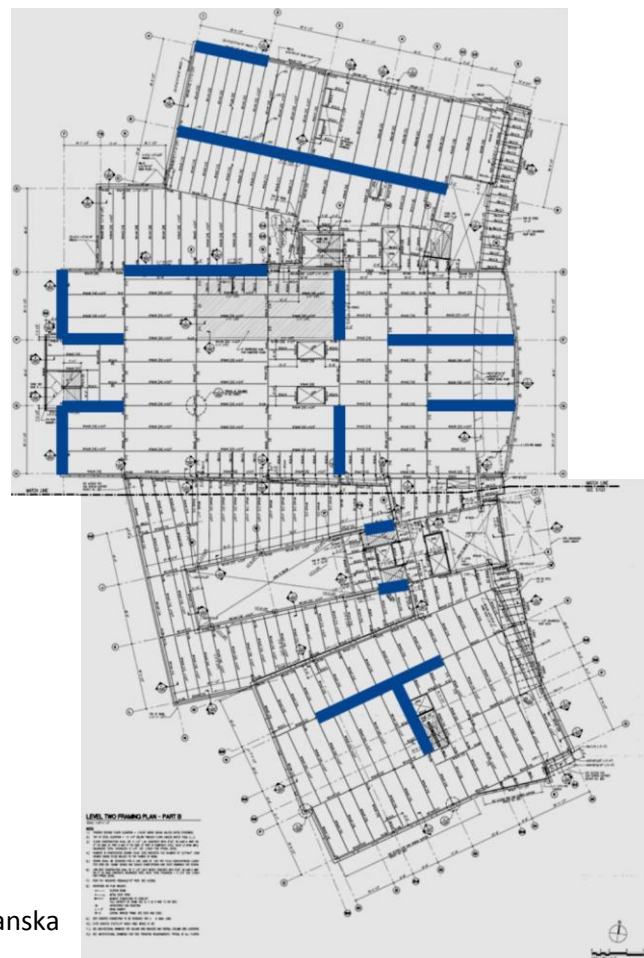

Codes and Standards

As Designed:

- 2000 ICC International Building Code
- 2000 ICC International Energy Conservation Code
- 2000 Americans with Disabilities Act – Accessibility Code
- 1999 National Electrical Code
- AIC 318 “Building Code Requirements for Structural Concrete”
- AIC 530 “Building Code Requirements for Masonry Structures”
- AISC Manual of Steel Construction (locally approved edition)
- ANSI “Structural Welding Code”

Thesis Calculations:

- American Society of Civil Engineers (ASCE) 7-10
- AISC Steel Construction Manual, 14th Edition
- ACI 318-11
- Vulcraft steel deck catalog

Design Loads

Dead Loads

Dead loads are estimated based off material weights found in the AISC Steel Construction Manual since no values were given on drawings except for weights of rooftop units which range from 8,000-45,000 lbs. Deck weight is compared to similar weights in Vulcraft catalog based on topping thickness and deck type.

Dead Loads	
Description	Load (psf)
Framing	10
Superimposed DL	10
MEP	10
Composite Deck	
3.25" LCW topping	42
4.75" LCW topping	50
5" NWC topping	70
Roof Garden	80
Façade	
Brick	40
Glass	10
Metal Panel	15

Live loads

Live load values were given on the drawings. These values are shown along with the values given in ASCE7-10 in the table below. Where values are not given in one source the value from the other source was used in calculations. Likewise, when differing values are present the larger of the two was used in thesis calculations.

Live Loads		
Description	Designed Load (psf)	ASCE 7-10 Load (psf)
Slab on grade	100	100
Library slab on grade	150	150
Storage	125	125
Offices	50 + 20 (partition allowance)	50 + 15 (partition allowance)
Classrooms	40 + 20 (partition allowance)	50 + 15 (partition allowance)
Corridors (elevated floors)	80	80
Lobbies	100	100
Recreational areas	100	100
Mechanical/Electrical	125	N/A
Stairs	100	100
Chiller room	150 + equipment	N/A
Boiler room	200 + equipment	N/A
Roof	30	20
Roof Garden	N/A	100

Snow Loads

With the use of flat roofs on 6 different levels, the snow loading for University Academic Center will be an important consideration when designing the roof members. Both uniform snow loading and drifting must be factored into design.

Using ASCE7-10 to confirm the design loads used on the building were efficient, a flat roof snow load of 15.75 psf was calculated. According to the plans, the building was designed conservatively for a snow load of 20 psf.

Basic snow drift calculations were also done to find the total snow loads including drift at 16 different locations of presumed maximum drift as well as when $I_u=20$ ft, the minimum length where drift calculations are necessary as defined in section 7.7.1. Snow is assumed unable to drift from one roof to another due to parapet walls. Calculation for drift around parapet walls may also be determined through the same procedure if required in future analysis. Resulting pressures are shown below and sample hand calculations can be found in the appendix.

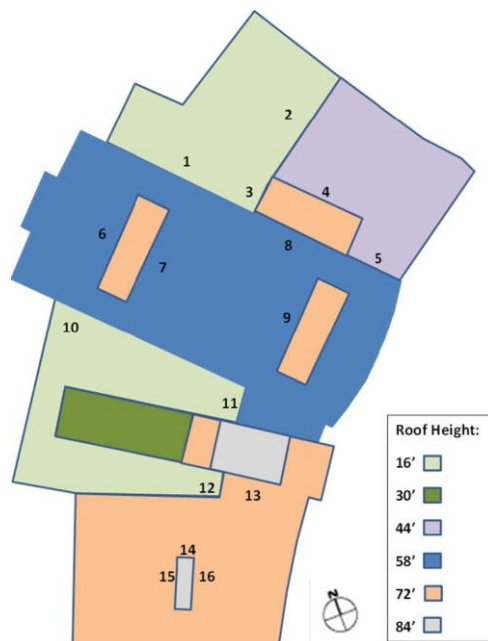

Snow Drift Calculations					
Location	I_u (ft)	h_d (ft)	p_d (psf)	w (ft)	p_{tot} (psf)
-	20	1.00	17.32	4.02	33.07
1	100	2.52	43.40	10.06	59.15
2	62	1.98	34.15	7.92	49.90
3	90	2.39	41.23	9.56	56.98
4	61	1.96	33.86	7.85	49.61
5	80	2.25	38.90	9.02	54.65
6	46	1.69	29.08	6.74	44.83
7	109	2.62	45.23	10.49	60.98
8	94	2.44	42.12	9.77	57.87
9	109	2.62	45.23	10.49	60.98
10	103	2.55	44.02	10.21	59.77
11	118	2.72	46.96	10.89	62.71
12	116	2.70	46.59	10.80	62.34
13	101	2.53	43.61	10.11	59.36
14	33	1.39	24.00	5.56	39.75
15	63	2.00	34.44	7.98	50.19
16	49	1.75	30.11	6.98	45.86

Wind Loads

Wind loads were calculated using the Directional Procedure found in ASCE7-10 Chapter 27. Preliminary values taken from the drawings along with detailed calculations in determining wind loads can be found in the hand calculations section of the appendix. An approximate building shape was taken for facilitating calculations based off the south and east elevations shown below. This simplification still required the determining of wind pressures for three levels. The wind pressures were then taken and converted into story forces for later use in lateral calculations including story drifts, max displacements, and overturning moment.

Based on the larger surface area in the N-S direction the forces at each story level are larger in the E-W wind direction. This translated into a larger base shear and larger overturning moment in the E-W wind direction.

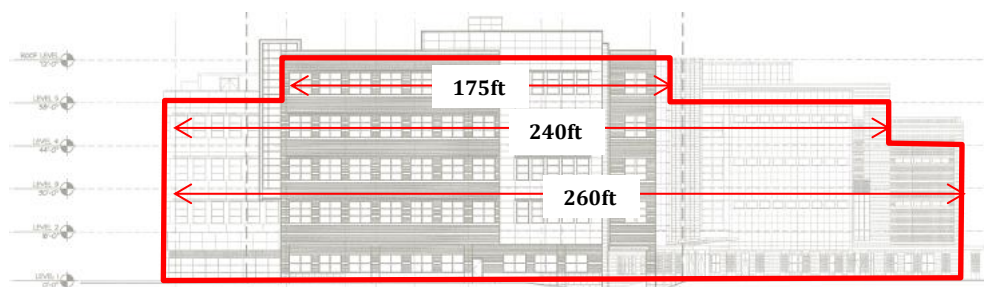

South Elevation provided by Skanska

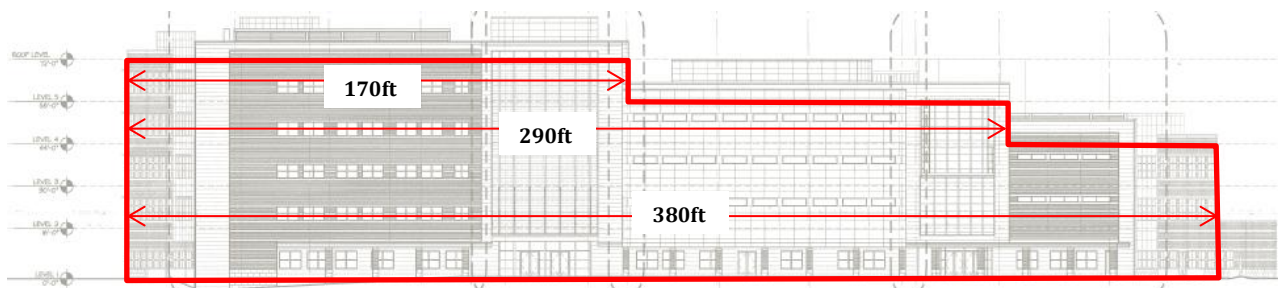

West Elevation provided by Skanska

Wind Pressures (N-S)					
Location	Height (ft)	q (psf)	Cp	Wind Pressure (psf)	Internal Pressure (psf)
Windward	0-16	24.75	0.8	16.83	+/- 5.81
	16-30	28.20	0.8	19.18	+/- 5.81
	30-44	30.50	0.8	20.74	+/- 5.81
	44-58	32.29	0.8	21.96	+/- 5.81
	58-72	33.90	0.8	23.05	+/- 5.81
Leeward	0-44	33.90	-0.41	-11.81	+/- 5.81
	44-58	33.90	-0.46	-13.25	+/- 5.81
	58-72	33.90	-0.5	-14.41	+/- 5.81
Side	0-72	33.90	-0.7	-20.17	+/- 5.81

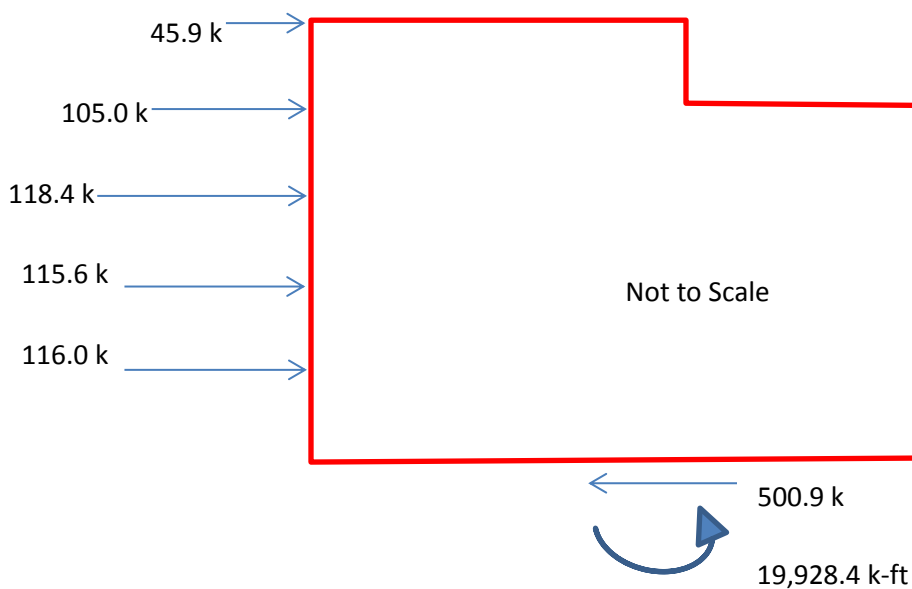
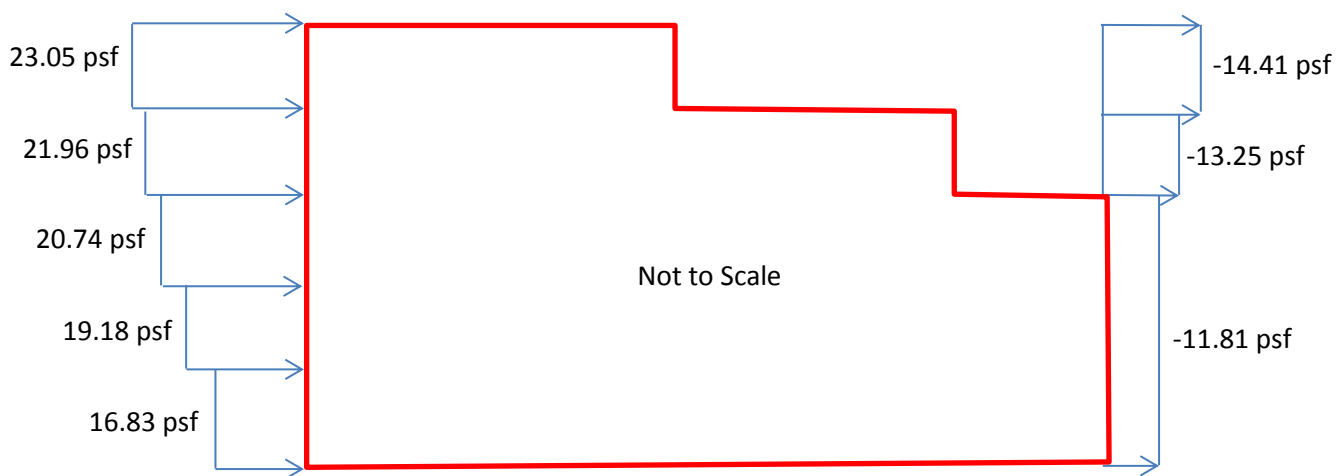

Wind Pressures (E-W)					
Location	Height (ft)	q (psf)	Cp	Wind Pressure (psf)	Internal Pressure (psf)
Windward	0-16	24.75	0.8	16.83	+/- 5.81
	16-30	28.20	0.8	19.18	+/- 5.81
	30-44	30.50	0.8	20.74	+/- 5.81
	44-58	32.29	0.8	21.96	+/- 5.81
	58-72	33.90	0.8	23.05	+/- 5.81
Leeward	0-44	33.90	-0.5	-14.41	+/- 5.81
	44-58	33.90	-0.5	-14.41	+/- 5.81
	58-72	33.90	-0.49	-16.61	+/- 5.81
Side	0-72	33.90	-0.7	-20.17	+/- 5.81

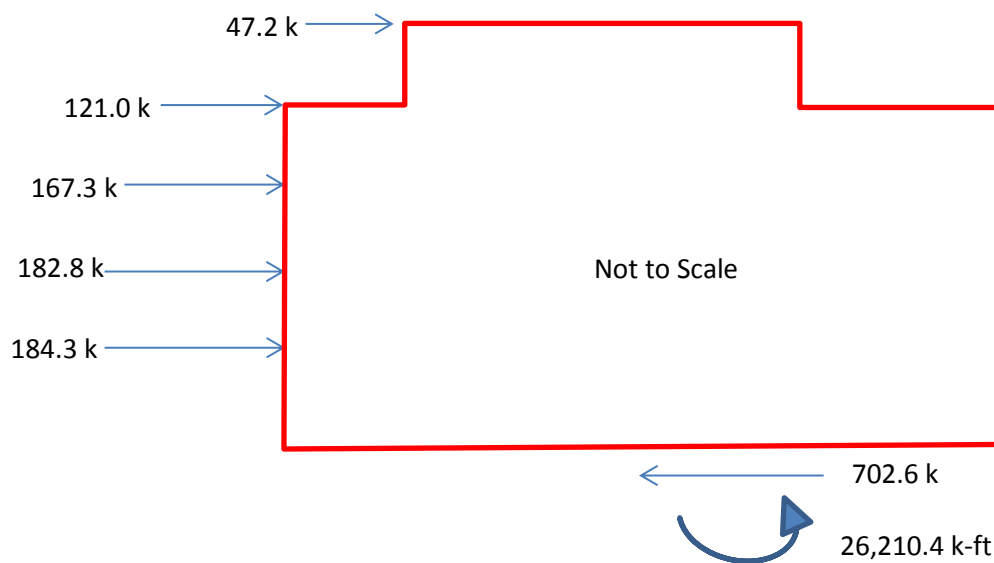
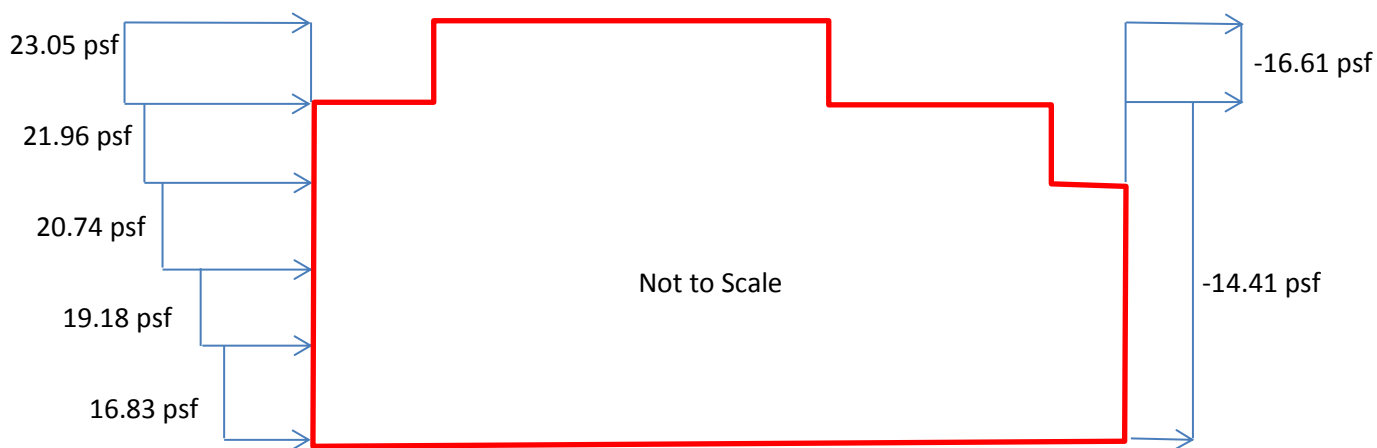

Seismic Loads

Seismic loading was designed using the Equivalent Lateral Force Procedure to follow the process used on the University Academic Center as stated in the drawings. Several design values were also given which when compared to the values calculated based on ASCE7-10 Equivalent Lateral Force Procedure, differed. However, both analyses resulted in similar base shear values. The as designed base shear is listed as 363 kip-ft, whereas the thesis calculated values came out to 377 kip-ft.

Seismic Load Calculation (N-S) & (E-W)						
Floor	Weight w_x (ft)	Height h_x (ft)	C_{vx}	Story Force F_x (kip)	Story Shear (kip)	Overturning Moment (kip-ft)
Ground	3,618	0	0	0	375	0
2	3,953	16	0.12	45	375	720
3	3,269	30	0.18	67.5	330	2,025
4	2,966	44	0.24	90	262.5	3,960
5	2,995	58	0.32	120	172.5	6,960
Roof	1,060	72	0.14	52.5	52.5	3,780
Total	17,861	-	1	375	-	17,445
Base Shear = 375 kip				Overturning Moment = 17,445 kip-ft		



Load Combinations

Load combinations taken from ASCE7-10 used in this report are shown below. Out of these load combinations only those containing wind and seismic loads need be considered since this portion of analysis only includes lateral effects on the structure. Load combinations 4 and 5 will govern for wind and seismic forces respectively. Load combinations 6 and 7 will control for evaluating overturning moments. In addition, the controlling wind load case taken from Figure 27.4-8 of ASCE7-10 must be determined as the wind load case used in the load combinations below.

2.3.2 Basic Combinations

Structures, components, and foundations shall be designed so that their design strength equals or exceeds the effects of the factored loads in the following combinations:

1. $1.4D$
2. $1.2D + 1.6L + 0.5(L_r \text{ or } S \text{ or } R)$
3. $1.2D + 1.6(L_r \text{ or } S \text{ or } R) + (L \text{ or } 0.5W)$
4. $1.2D + 1.0W + L + 0.5(L_r \text{ or } S \text{ or } R)$
5. $1.2D + 1.0E + L + 0.2S$
6. $0.9D + 1.0W$
7. $0.9D + 1.0E$

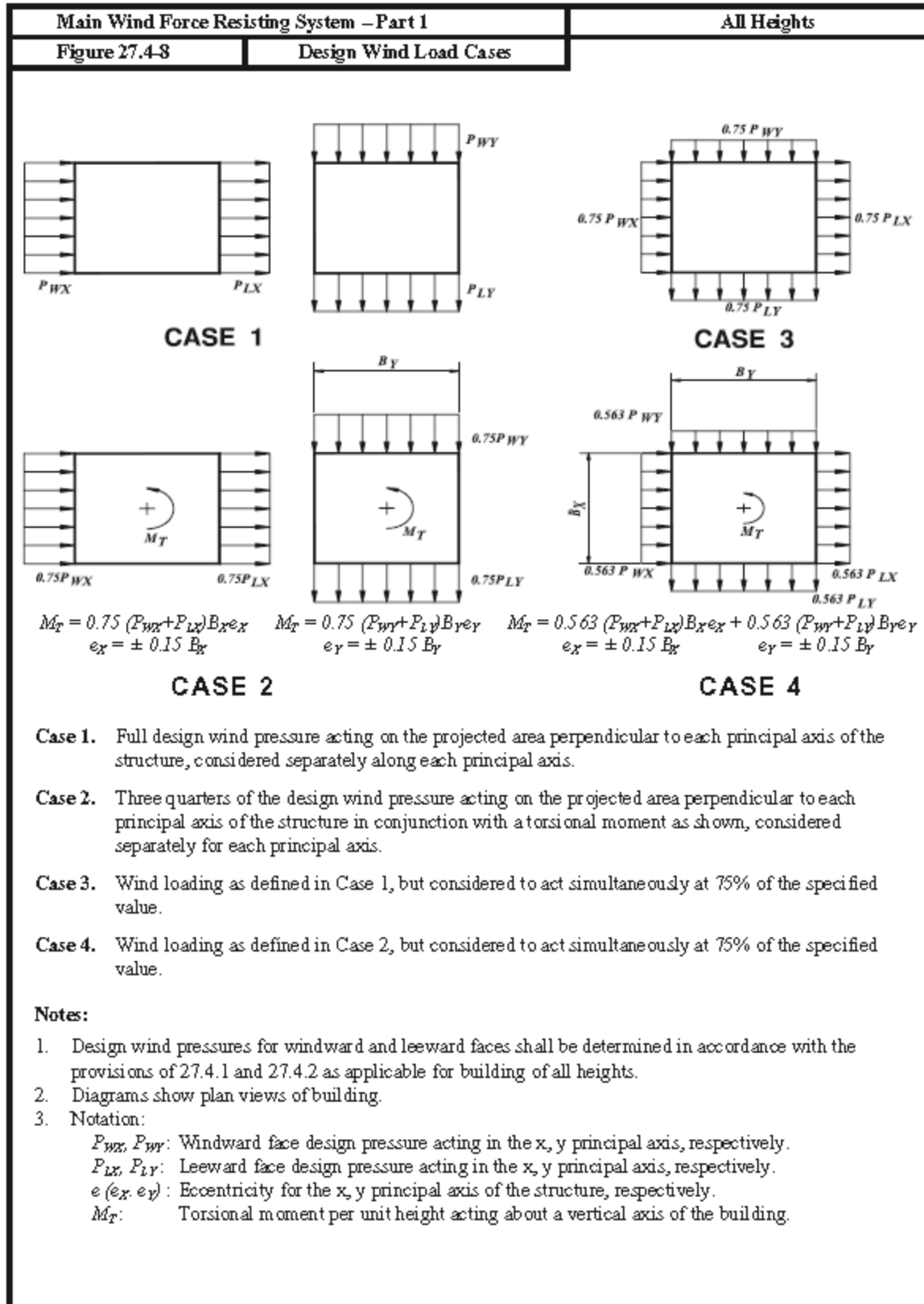

Wind Load Cases

Case 1 (N-S)		Case 1 (E-W)	
Story	Load (k)	Story	Load (k)
5	45.9	5	47.2
4	105	4	121
3	118.4	3	167.3
2	115.6	2	182.8
1	116	1	184.3

Case 2 (N-S)			Case 2 (E-W)		
Story	Load (k)	M _T (k-ft)	Story	Load (k)	M _T (k-ft)
5	34.4	83.8	5	35.4	128.9
4	78.8	209.5	4	90.8	360.9
3	88.8	193.7	3	125.5	518.2
2	86.7	184.4	2	137.1	495.2
1	87	170.4	1	138.2	494.2

Case 3			Case 4			
Story	(N-S) Load (k)	(E-W) Load (k)	Story	(N-S) Load (k)	(E-W) Load (k)	M _T (k-ft)
5	34.4	35.4	5	25.8	26.6	159.7
4	78.8	90.8	4	59.1	68.1	428.2
3	88.8	125.5	3	66.7	94.2	534.4
2	86.7	137.1	2	65.1	102.9	510.2
1	87	138.2	1	65.3	103.8	498.9

Seismic Load Cases

(N-S) & (E-W)	
Story	Load (k)
5	45
4	67.5
3	90
2	120
1	52.5

Proposed Structural Depth

The completion of technical reports 1, 2, and 3 showed the current structural systems used in University Academic Center are adequate in meeting both strength and serviceability requirements. This eliminates any need to redesign in order to fix issues or meet codes. Instead this next phase of thesis work will be dedicated to redesigning the building to expand knowledge of structural systems.

With the current building being composed entirely of steel systems, the option of redesigning the office wing with a concrete structural system will be done in order to further knowledge in concrete design. This option will include designing a new flooring system and designing the concrete moment frames to resist both gravity and lateral forces. The office wing is the most suited for a concrete system with its masonry enclosure already giving it a more massive feel, and its repeated floor layouts.

The research into alternate flooring systems done in technical report 2 suggested a two-way slab flooring system would offer advantages over the existing composite steel system such as price and floor-to-floor heights. These advantages will be further investigated in the new concrete office wing.

The two-way slab must be designed including slab thickness, rebar sizing and placement, column sizing and layout, and the sizing of drop panels if necessary. These values will be tested to comply with current code requirements and compared to the current composite steel system for feasibility.

The lateral system will also be redesigned in the form of concrete moment frames in the office wing as opposed to the current braced frame system. The change to a concrete system and the additional stiffness may reduce the building's overall torsional effects. Design will include reinforcement and thickness calculations. The data will be entered into a computer program such as ETABS and compared to the current lateral system for values including story drift, total displacement, and torsion as determined in technical report 3.

Cracking and settlement issues could become a problem when connecting two differing structural systems. The relationship between the two systems must be a stable one. Because of this, the connection between the concrete office wing and the steel building will be detailed and designed accordingly.

The foundation must also be investigated in the new concrete wing to ensure the added weight will still be supported by the foundation. If this is not the case the foundation will have to be redesigned.

Breadth 1: Lighting Impact

As determined from technical report 2, changing the flooring system will most likely result in an increase of floor to floor height. In order to keep the exterior architectural appearance of the building unchanged this will result in greater ceiling heights on each floor. If the current recessed lighting's height were to increase the light levels experienced in the spaces could change. Therefore the option of changing the recessed lighting over to a pendant lighting layout in the office wing will be explored.

An interior space will be chosen and analyzed with software to determine current lighting levels. Then new pendant lighting will be selected to replace the recessed lighting. The interior space will then be reanalyzed to determine if lighting levels changed. Rearranging of pendant lighting will be done if new lighting levels are too low until levels are acceptable.

Breadth 2: Construction Impact

The building of a concrete office wing will place a big change on the building's schedule; this change will be addressed in a construction breadth along with a cost comparison of the concrete system versus the composite steel system currently employed. Detailed take-offs of material costs using RSMeans will compare the two systems and determine which is cheaper. A schedule will also be created for the concrete office wing and fitted into the actual schedule to determine the impact on critical path and construction times.

Tasks & Tools

Structural Depth

1. Design two-way slab system
 - a. Determine column layout
 - b. Determine slab thickness
 - c. Design columns
 - d. Model floor system in spSlab/spColumn to size reinforcement and verify strength and serviceability requirements
2. Recalculate building weight
3. Recalculate seismic loading values
4. Design lateral system
 - a. Design concrete moment frames

- b. Test building for lateral strength and serviceability in ETABS
5. Research concrete/steel system connection
6. Design steel/concrete connection and test strength and serviceability
7. Check and redesign foundations as necessary

Breadth 1: Lighting Impact

1. Determine current lighting levels of an interior space with lighting analysis software
2. Replace recessed lighting with pendant lighting fixtures to account for higher floor to floor height
 - a. Document hardware data and specifications
3. Reanalyze interior space with new pendant fixtures for lighting levels
4. Reconfigure fixture layout as necessary to achieve current lighting levels
5. Comment on effects to electric load if changes occur

Breadth 2: Construction Impact

1. Create detailed material take-offs for both the existing office wing and the concrete redesign for cost comparison using RSMeans
2. Modify existing schedule to include the concrete redesign of the office wing using MS Project
3. Comment on cost and schedule differences due to concrete redesign

Conclusion

By changing the office wing into a concrete structural system a knowledge of concrete design not tested in the previous technical reports will be gained including but not limited to gravity and lateral systems. Also the practice of connecting differing structural systems will be introduced as a learning experience. This structural depth topic allows for the integration of closely related breadth topics of construction and architectural impacts on the current design. Examining the effects changing the structural system has on other areas of the building will give greater insight into the consequences of structural decisions.

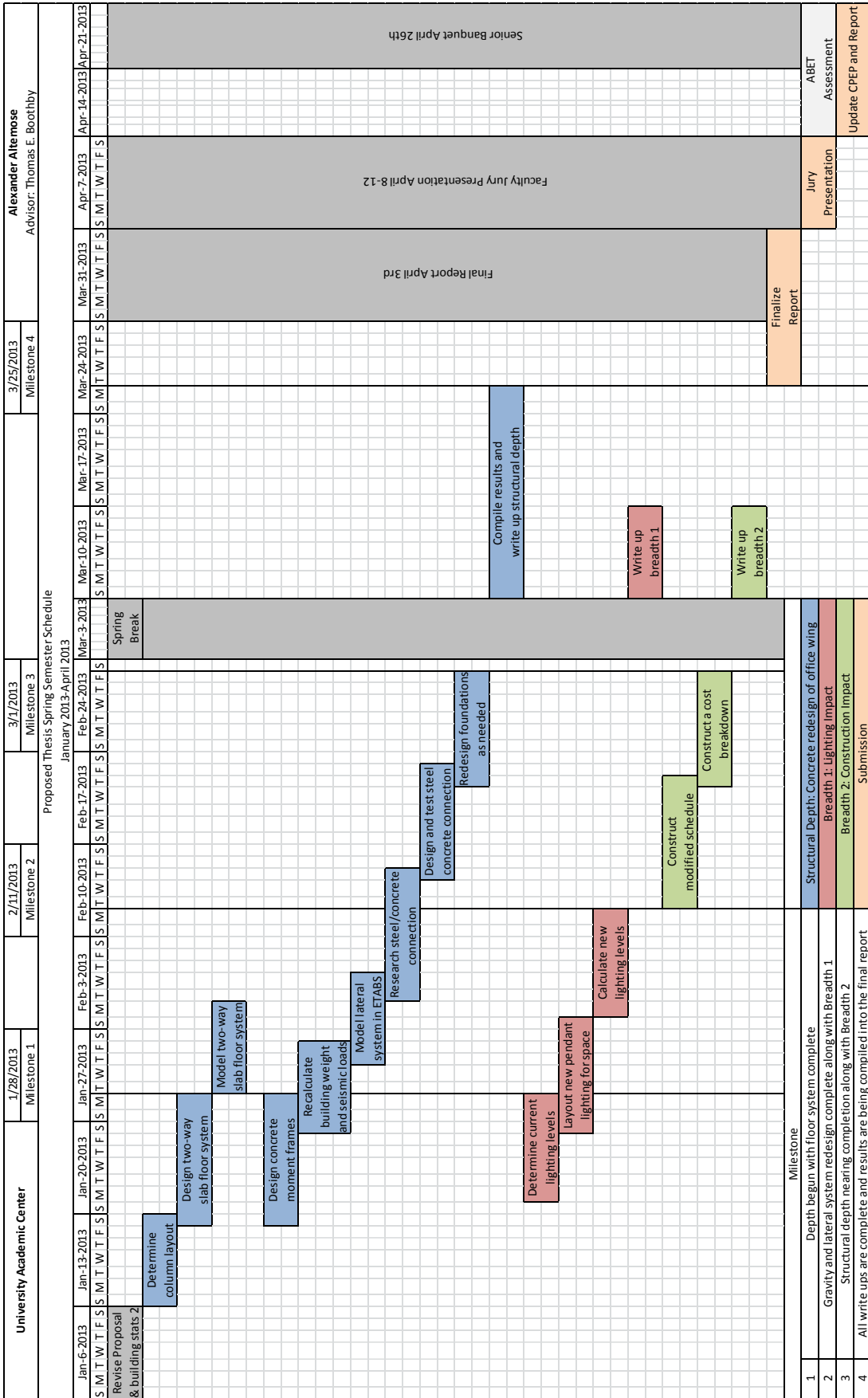

- 1 Milestone
 - 2 Depth begun with floor system complete
 - 3 Gravity and lateral system redesign complete along with Breadth 1
 - 4 Structural depth nearing completion along with Breadth 2
- All write ups are complete and results are being compiled into the final report

Appendix: Floor Plans

